

**VALVE POSITION
INDICATING DEVICES**

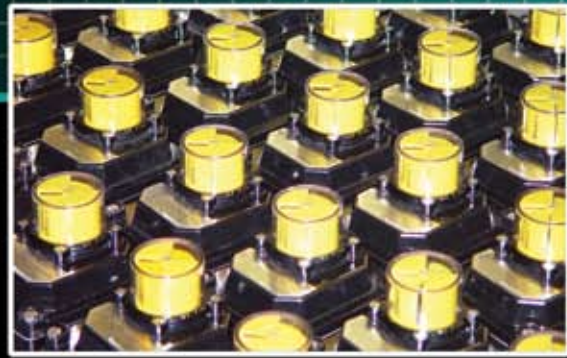

Efficient, Reliable Indication Solutions for Today's Most Challenging Applications

SeniTec's ongoing advancements in valve position indicating technology and process controls deliver the most efficient and reliable indication solutions for today's most challenging applications.

Enclosures to include NEMA 3, 4, 4x, 7 and 9 are available for your most demanding applications. Manufactured to the highest standards for performance in a wide variety of working environments, the **SeniTec** line of Valve Position Indicating Devices offers you both reliable performance and maximum flexibility.

SeniTec's position indicating devices are available with the following options: mechanical, inductive, SPDT, DPDT, hermetically sealed proximity sensors, multiple switch configurations, internal solenoid valves and "AS-i" networking. Mechanical Switches are 10 amp SPDT as standard — all switch options are enclosed on a PCB board with no exposed wiring. **SeniTec** also offers a 100 mA (.1A) gold plated SPDT switch for low power and intrinsically safe applications.

SeniTec Brings You Reliable Solutions for a Variety of Applications and Work Environments.

4 to 20 mA

Position Transmitter Feedback

Position transmitters provide a precise 4 to 20 mA signal on two wire DC loop. Quarter Turn valves and dampers are accurately monitored through their range of travel giving you confidence of exact valve positioning.

Make the switch to SeniTec Valve Position Indicating Devices... no other limit switch has this much experience with valve indication.



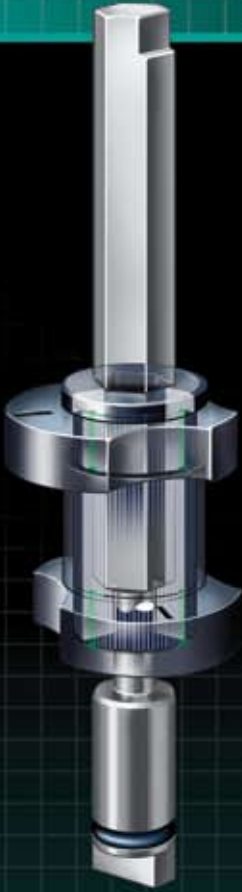

Setting System

Easy "Set and Forget" Cam Design

This cam setting system uses no mechanical devices (springs or screws) for adjustment. **SeniTec** utilizes a unique internal leaf spring design, which precisely positions and locks on to a splined shaft, which prevents calibration and life cycle inaccuracies. When needed, the cam system is easily adjusted using no tools.

Mechanical Switch

Accuracy, Performance, Flexibility & Reliability

Mechanical Switch (SPDT) - Single pole, double throw 10 AMP mechanical switches with silver contacts are recommended for high power 125 VAC applications. Gold contacts are available in 100mA for typical computer input applications.

Mechanical Switch (DPDT) - Double pole, double throw mechanical switches permit two electrical circuits to be activated concurrently. Each switch circuit is electrically isolated from the other. As with our SPDT 10 AMP mechanical contacts, DPDT switches are designed to operate high power applications.

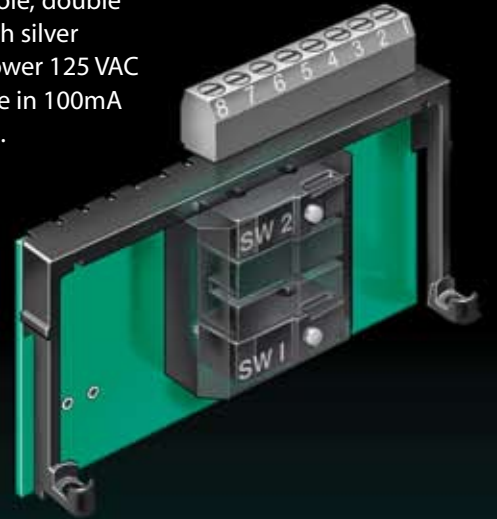

PrE2 Proximity Sensor

Providing Safety Protection & Critical Reliability

When accuracy, performance and reliability are critical, the **SeniTec** PrE2 proximity sensor provides the answer. Encased in a Sentar housing and hermetically sealed with epoxy Ackralite, the PrE2 proximity sensor provides the industry's foremost protection from moisture, shock and corrosive environments as well as electronic spikes that damage and shorten the life cycle capacity of traditional VPIDs.



Easy Wire Termination

Configured with no exposed wiring, our position indicating devices offer easy wire termination coupled with the necessary space for the most difficult installation. Options include stationary or plug-in terminal strip 8 or 14 points.





NEMA 3, 4, 4x

Valve Position Indicating Device

SeniTec's NEMA 3, 4, 4x valve position indicating devices offer FDA approved co-polyester alloy NEMA 4 housings for use in the most demanding environments. Made from Sentar Co-Polyester alloy along with stainless steel trim, these valve position indicating devices allow for years of maintenance-free service.

The extraordinary toughness, superior chemical resistance and excellent impact strength creates a new generation of VPIDs. SeniTec's VPIDs are also available in stainless steel and aluminum housings for use in demanding operating environments.



SENTAR NEMA 4

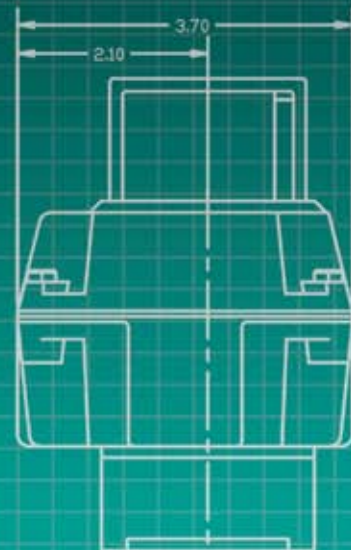
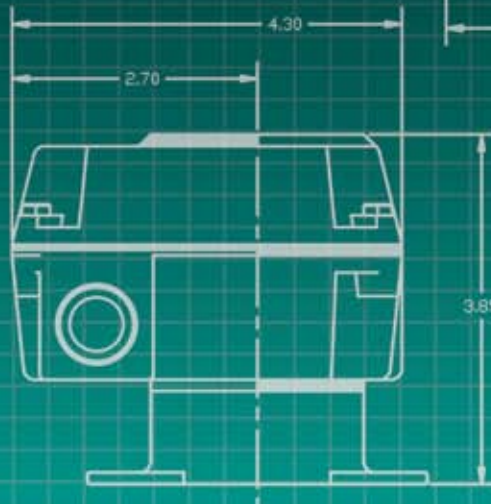
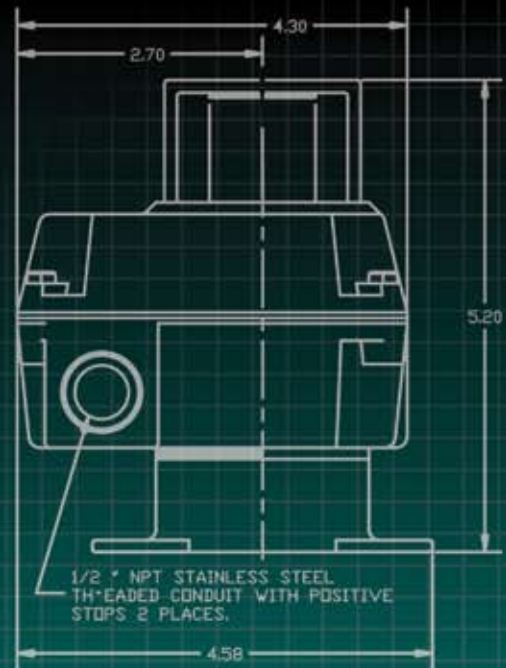

A Proven Performer





NEMA 3, 4, 4x Part Numbering Chart

ENCLOSURE TYPE A=SENTAR (1/2 SS inserts) B=AL (3/4 NPT) C=SS (3/4 NPT)	ENCLOSURE TYPE CONDUITS/RECEPTACLES BEARINGS INDICATOR SWITCH TYPE	CONDUITS/RECEPTACLES A=STD 2 1/2" Female B=3 1/2" Female C=2 1/2" Female, 1 1/2" Male D=Mini 5-Pin AC Receptacle E=Micro AS-i Receptacle F=Micro 4-Pin DC Receptacle	INDICATOR A=STD 90° Black/Yellow B=90° Blue/White C=90° Red/White D=90° Green/White E=90° Red/Green F=90° 3 Way G=90° 3 Way H=90° 3 Way I=180° 3 Way J=180° 3 Way K=90° 4 Way L=Defined By User N=None	SWITCH TYPE A=STD 10 AMP Mechanical B=100ma Gold Mechanical C=3 Amp Proximity D=1 Amp Proximity E=2 Amp DPDT Mechanical F= Shadow ACDC Term Chamber G=Shadow AS-i Term Chamber	Number of Switches 1=1 2=2 3=3 4=4 0= None
SHAFT 1=303 SS NAMUR 2=316 SS NAMUR 3=303 SS 1/4 DD 4=316 SS 1/4 DD		TERMINAL STRIP 1=8 Pole Fixed 2=8 Pole Plug In 3=14 Pole Fixed 4=14 Pole Plug In 5=AS-i 8 Pole Fixed			MOUNTING (L x W x H) 1=80x30x20mm NAMUR 2=80x30x30mm NAMUR 3=130x30x30mm NAMUR 4=130x30x20mm NAMUR 5=2.25 SQ w/4 5/16-18 (no brkt) 6=80x30x10mm NAMUR

A
A
E
A
A
2
1
1
1
0

NEMA 7 Valve Position Indicating Device

The NEMA 7 enclosure is made from heavy-duty aluminum with a powder coated epoxy paint finish to withstand the challenges of your hazardous environment applications. Included are options for mechanical, proximity switches, "AS-i" networking as well as a variety of mounting brackets and mounting configurations.









Turn the page for NEMA 7 Part Numbering Chart and dimensions.



NEMA 3, 4, 4X, 7, 9
Class I & II, Div. I & II, Groups C-G
Class I, Div. II, Groups A & B

Part Numbering Chart

ENCLOSURE TYPE Z = AL (3/4 NPT)
CONDUITS / RECEPTACLES A = STD 2 3/4" Female B = 3 3/4" Female C = 2 3/4" Female, 1 1/2" Male D = MINI 5-Pin AC Receptacle E = Micro AS-i Receptacle F = Micro 4-Pin DC Receptacle
BEARINGS B = Bronze S = Stainless Steel
INDICATOR A = STD 90° Black / Yellow B = 90° Blue/White C = 90° Red/White D = 90° Green/White E = 90° Red/Green F = 90° 3 Way  G = 90° 3 Way  H = 90° 3 Way  I = 180° 3 Way  J = 180° 3 Way  K = 90° 4 Way  L = Defined By User N = None
SWITCH TYPE A = STD 10 AMP Mechanical B = 100ma Gold Mechanical C = 3 Amp Proximity D = 1 Amp Proximity E = 2 Amp DPDT Mechanical F = Shadow ACDC Term Chamber G = Shadow AS-i Term Chamber

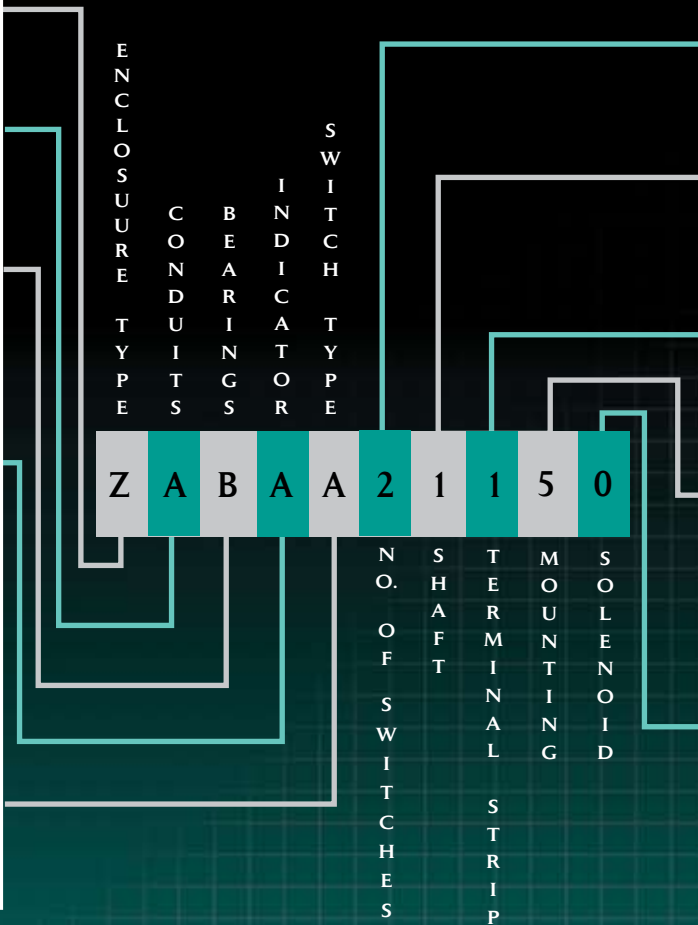

Number of Switches 1=1 2=2 3=3 4=4 0= None
SHAFT 1=303 SS NAMUR 2=316 SS NAMUR 3=303 SS 1/4 DD 4=316 SS 1/4 DD
TERMINAL STRIP 1=8 Pole Fixed 2=8 Pole Plug In 3=14 Pole Fixed 4=14 Pole Plug In 5=AS-i 8 Pole Fixed
MOUNTING (L x W x H) 1=80x30x20mm NAMUR 2=80X30X30mm NAMUR 3=130x30x30mm NAMUR 4=130x30x20mm NAMUR 5=2.25 SQ w/4 5/16-18 (no brkt) 6=80x30x10mm NAMUR
SOLENOID 0=None 1=3 WAY 24 VDC 0.2 AMP 2=4 WAY 24VDC 0.2 AMP 3=24 VDC Low Power (80ma)
INTERNAL SOLENOID 4=12 VDC 5=24 VDC 6=125 VDC 7=120 VAC
FEEDBACK OPTIONS 8=4-20mA 9=1000 Ohm Pot

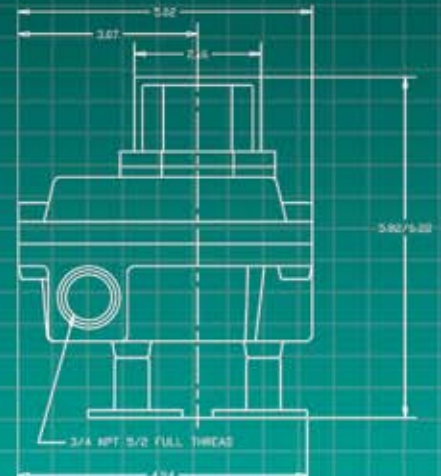
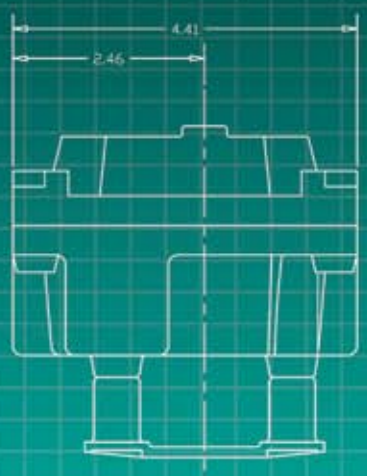
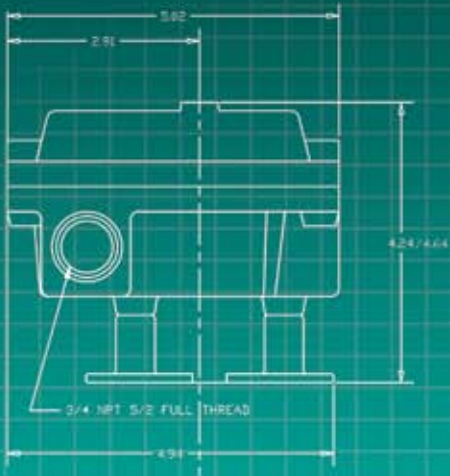

Part Numbering Chart

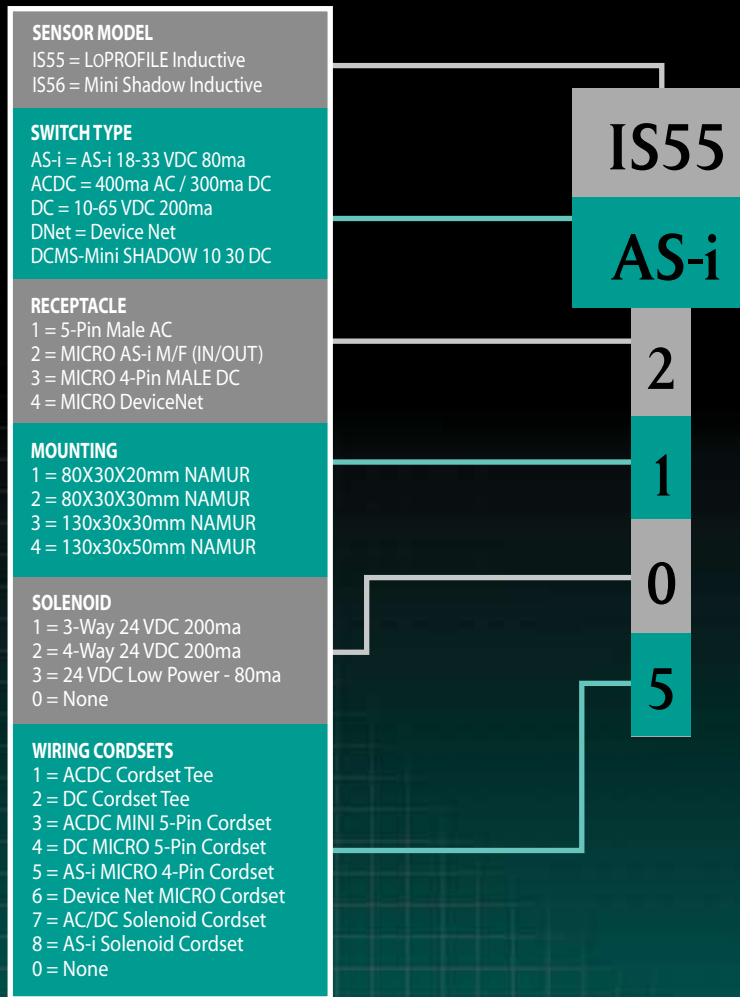

Shadow Switch

SeniTec's Shadow Switch is a solid-state sensor constructed of an engineered resin that is suitable for outdoor and indoor applications. The Shadow mounts directly to VDI/VDE 3845 actuators for a very low profile. There are no moving parts which ensures trouble-free service.

Rated for Nema 4, 4x and can be used in intrinsically safe areas with proper barriers and cabling. Also available with "AS-i" Network Module.





INTEGRATED SOLENOID PILOT VALVE SWITCH

Proving **SeniTec's** commitment to being the industry leader in valve positioning, we're proud to add the Integrated Solenoid Pilot Valve Switch to our great line of products. The **SeniTec** Switch incorporates our solenoid coil housed in the 4, 4X, 7 and 9 Aluminum box and is available in 120 VAC, 12 VDC, 24 VDC and 125 VDC coil configurations.

Specifically engineered for hazardous and corrosive applications, our Integrated Solenoid Pilot Valve Switch eliminates the need for expensive solenoid piping and wiring to the switch. The switch is available in SPDT, DPDT and proximity configurations with Namur mounting for ease of installation.

Designed with the standard **SeniTec** features of quick set and forget cams, switches on circuit boards with no exposed wiring, captive cover screws, and globally approved certification, specifying the **SeniTec** Integrated Pilot Valve Switch is today's industry standard in valve position monitoring.



2150 Boggs Road • Suite 410 • Duluth, GA 30096
770-416-1202 sales@senitec.com

*For additional information regarding our products,
please phone our office or visit us on the web at:*

www.senitec.com

